

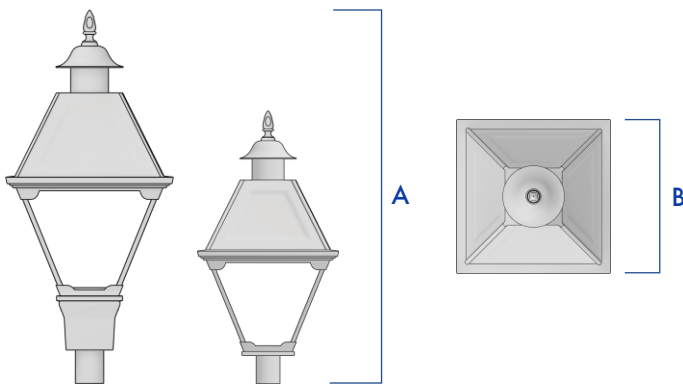

DIMENSIONS



FIXTURE	A	B
CL	43"	17.5"
CL-S	27.75"	15"

LUMINAIRE HOUSING

Main Housing and Electrical Compartment constructed from four-sided cast aluminum alloy (A356; .2% Cu) including Electrical Compartment cover. A barrier wall is cast in place between the optical section and the electrical compartment. All exposed hardware is stainless steel.

LED EMITTERS & OPTICS

Optical plate of .125" sheet aluminum (alloy 6063; ≥ -1% Cu) provides mounting surface for the 4-Squared Optics. Internally, extruded aluminum heatsinks are located behind each optic. Optical plate is recessed to shield the 4-Squared optics against uplight providing a U0 B-U-G rating. The 4-Squared emitters have 4 emitters per die with 4 dies per Optic allowing 16 emitters per 4-Squared Optic. Emitters are >70CRI.

LumenUs silicone lens material is heat resistant to 200°C and retains 96% optical clarity. Silicone material is flexible making it impact resistant. Each LumenUs silicone lens covers 4 emitter dies and seals each optic to meet an IP67 rating. The optical system produces standard site/area distributions and are field replaceable and rotatable in 90° increments. All hardware is stainless steel.

DRIVER & ELECTRICAL

Driver(s) are constant current electronic with a minimum operating temperature of -40°F/-40°C. Driver(s) is/are UL and cUL recognized and have a power factor of >.90.

Drivers accept an input voltage of 120-277V, 50/60Hz or 347V-480V, 50/60Hz. (0 - 10V dimming is standard). A separate 20KV surge suppressor is installed on the incoming power side of the driver assembly.

COLOR & FINISH

Super TGIC thermoset polyester powder coat paint, 2.5 mil minimum thickness, is applied over a 5-step pretreatment cleaning and sealing process. Super TGIC powder coat paint is cured at a minimum of 400°F for 30 minutes. Standard colors are Dark Bronze, Black, Green, Gray - ANSI 70, and White.

CERTIFICATIONS & STANDARDS









Project Name: _____

Type: _____

Specification/Order: _____

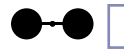
MOUNTING CONFIGURATIONS

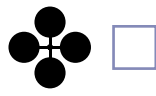
Note: E.P.A. values do not include arm
E.P.A. values

1  <input type="checkbox"/>	2-180  <input type="checkbox"/>	3-120  <input type="checkbox"/>	4-90  <input type="checkbox"/>
	2-90  <input type="checkbox"/>	3-90  <input type="checkbox"/>	

Note: 3-120 mounting requires a round pole or tenon mount option

LUMINAIRE SIZE

CL <input type="checkbox"/>	CL-S <input type="checkbox"/>
---------------------------------------	---

DISTRIBUTIONS

 TYPE II T2 <input type="checkbox"/>	 TYPE III T3 <input type="checkbox"/>	 TYPE IV T4 <input type="checkbox"/>	 TYPE V T5S <input type="checkbox"/>
---	--	--	--

4-SQUARED LED OPTICS

4Q1 = 16 LED
4Q2 = 32 LED
4Q3 = 48 LED
4Q4 = 64 LED

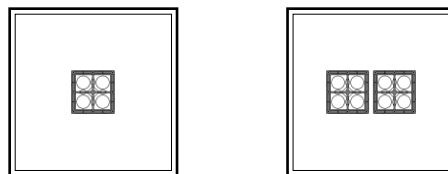

DRIVE CURRENT 70 = 700mA 105 = 1050mA	4Q1-70 <input type="checkbox"/>	4Q2-70 <input type="checkbox"/>
	4Q1-105 <input type="checkbox"/>	4Q2-105 <input type="checkbox"/>

LED COLOR TEMPERATURE

70CRI Standard

3000K CCT Warm White <input type="checkbox"/>	4000K CCT Neutral White <input type="checkbox"/>	5000K CCT Cool White <input type="checkbox"/>
--	---	--

VOLTAGE

Drivers used are voltage sensing

120 <input type="checkbox"/>	240 <input type="checkbox"/>	347 <input type="checkbox"/>	120-277* <input type="checkbox"/>
208 <input type="checkbox"/>	277 <input type="checkbox"/>	480 <input type="checkbox"/>	347-480* <input type="checkbox"/>

(* 120-277V and 347-480V are voltage and frequency (50-60HZ) sensing)

Spec/Order Configuration



Project Name: _____

Type: _____

Specification/Order: _____

FINISH COLOR Super TGIC Polyester Powder Coat Paint	DBZ <input type="checkbox"/> Dark Bronze	WHT <input type="checkbox"/> White	GRY <input type="checkbox"/> Gray - ANSI 70			
	BLK <input type="checkbox"/> Black	GRN <input type="checkbox"/> Green	CC <input type="checkbox"/> Custom Color - Define			
All RAL colors are available						
OPTION: HOUSE SIDE SHIELDS	HSS1 <input type="checkbox"/>	HSS2 <input type="checkbox"/>				
OPTION: PHOTOCELL	PC-X Button Style 1 Photocell (X = Specify voltage) <input type="checkbox"/>	PCR7 7-Pin Twistlock Receptacle with Shorting Cap ANSI 136.41 <input type="checkbox"/>	Use of the PCR7 option requires an accessory mounting component on pole or arm			
OPTION: FUSING	SF Single Fusing 120V, 277V, 347V <input type="checkbox"/>	DF Double Fusing 208V, 240V, 480V <input type="checkbox"/>				
OPTION: MOTION SENSOR	FSP-311 Photocell/Motion Sensor Combo (Programmable via Bluetooth) <input type="checkbox"/> FSP-311 option mounts to the Optical Plate					
OPTION: MOUNTING	PT23 Ø2.375" Tenon <input type="checkbox"/>	PT27 Ø2.875" Tenon <input type="checkbox"/>	PT30 Ø3" Tenon <input type="checkbox"/> Contact factory for other options			
OPTION: LENS	CSA Clear Smooth Acrylic <input type="checkbox"/>	CSP Clear Smooth Polycarbonate <input type="checkbox"/>	CPA Clear Patterned Acrylic <input type="checkbox"/>	CPP Clear Patterned Polycarbonate <input type="checkbox"/>	OSA* Opal Smooth Acrylic <input type="checkbox"/>	OSP* Opal Smooth Polycarbonate <input type="checkbox"/>

*Apply LLF of 10% to lumen output chart

0.25fc Part Number: 4Q1-105-4K (55W)
0.5fc Mounting Height: 12'
1.0fc Iso-footcandle Plot Units = Mounting Height (12')

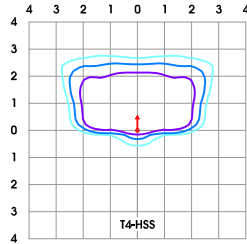
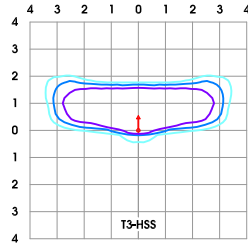
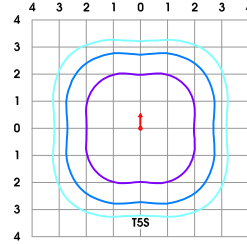
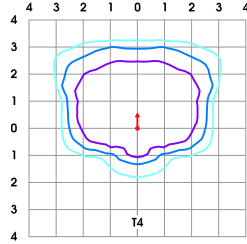
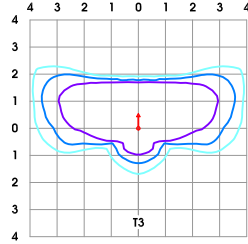
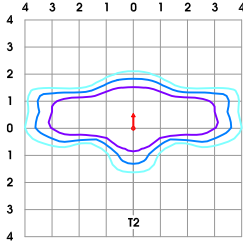

LED/Electrical Data

CCT	LED Optic	Drive Current	Type II	Type III	Type IV	Type V Square	Watts	Volts	Amps
3000K	4Q1 - 16 LED	700mA	4169 lm	4295 lm	4129 lm	4177 lm	35	120	.30
	B-U-G		B1-U0-G1	B1-U0-G1	B1-U0-G1	B1-U0-G1		277	.13
	4Q2 - 32 LED	700mA	8338 lm	8591 lm	8257 lm	8353 lm	70	120	.59
	B-U-G		B2-U0-G2	B2-U0-G2	B2-U0-G2	B2-U0-G2		277	.26
	4Q1 - 16 LED	1050mA	5670 lm	5842 lm	5615 lm	5680 lm	55	120	.49
	B-U-G		B1-U0-G1	B1-U0-G1	B1-U0-G1	B1-U0-G1		277	.20
4000K	4Q2 - 32 LED	1050mA	11340 lm	11683 lm	11230 lm	11360 lm	110	120	.92
	B-U-G		B2-U0-G2	B2-U0-G2	B2-U0-G2	B2-U0-G2		277	.40
	4Q1 - 16 LED	700mA	4424 lm	4558 lm	4381 lm	4432 lm	35	120	.30
	B-U-G		B1-U0-G1	B1-U0-G1	B1-U0-G1	B1-U0-G1		277	.13
	4Q2 - 32 LED	700mA	8848 lm	9116 lm	8762 lm	8864 lm	70	120	.59
	B-U-G		B2-U0-G2	B2-U0-G2	B2-U0-G2	B2-U0-G2		277	.26
5000K	4Q1 - 16 LED	1050mA	6017 lm	6199 lm	5958 lm	6028 lm	55	120	.49
	B-U-G		B1-U0-G1	B1-U0-G1	B1-U0-G1	B1-U0-G1		277	.20
	4Q2 - 32 LED	1050mA	12033 lm	12398 lm	11916 lm	12055 lm	110	120	.92
	B-U-G		B2-U0-G2	B2-U0-G2	B2-U0-G2	B2-U0-G2		277	.40
	4Q1 - 16 LED	700mA	4496 lm	4632 lm	4452 lm	4504 lm	35	120	.30
	B-U-G		B1-U0-G1	B1-U0-G1	B1-U0-G1	B1-U0-G1		277	.13
	4Q2 - 32 LED	700mA	8992 lm	9264 lm	8904 lm	9008 lm	70	120	.59
	B-U-G		B2-U0-G2	B2-U0-G2	B2-U0-G2	B2-U0-G2		277	.26
4Q1 - 16 LED	1050mA	6114 lm	6300 lm	6055 lm	6125 lm	55	120	.49	
B-U-G		B1-U0-G1	B1-U0-G1	B1-U0-G1	B1-U0-G1		277	.20	
4Q2 - 32 LED	1050mA	12229 lm	12599 lm	12110 lm	12251 lm	110	120	.92	
B-U-G		B2-U0-G2	B2-U0-G2	B2-U0-G2	B2-U0-G2		277	.40	