

BXC PENDANT MOUNT ARM

DESCRIPTION

This versatile arm is suited for traditional and contemporary fixtures. The BXC arm is ideal for courtyards, pathways, municipal, and commercial decorative light pole applications.

FEATURES

Decorative cast aluminum and extruded aluminum pole or wall bracket mounting.

Mounts to 2 $\frac{3}{8}$ " or 2 $\frac{7}{8}$ " O.D. tenon.

Extruded aluminum, Schedule 40 wall thickness.

6061 alloy T-6 temper with cast aluminum slip fitter.

Stainless steel hardware.



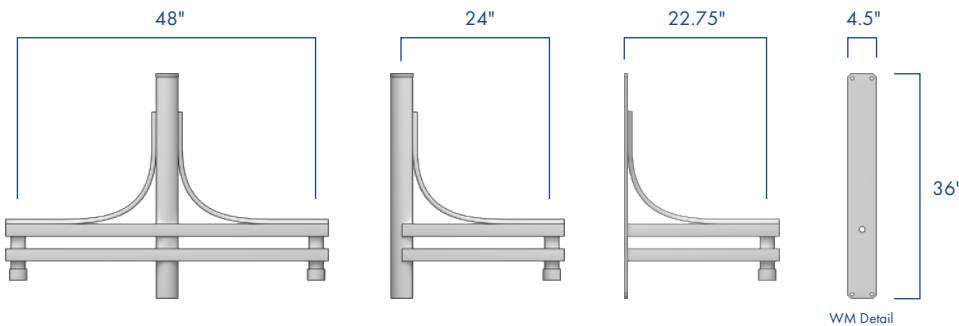
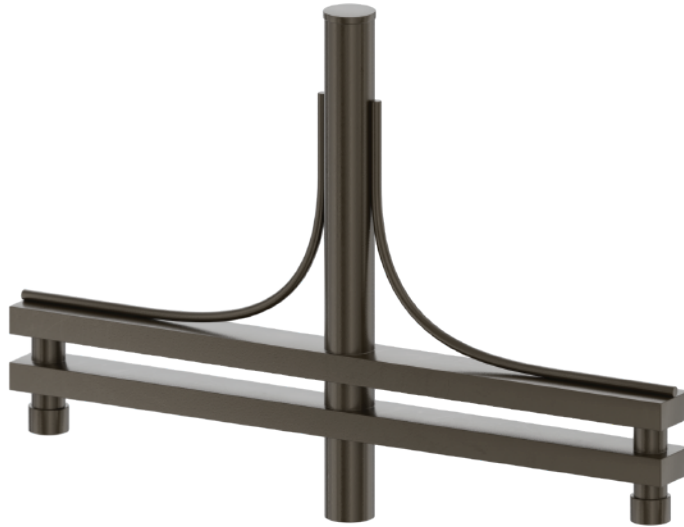



TGIC thermoset polyester powder coat finish is electrostatically applied at a 3.0 mil nominal thickness. A five stage metal pre-treatment process and sealer provide maximum corrosion resistance. The powder top coat is baked in excess of 400 degrees for supreme endurance.



SUITABLE FOR
WET
LOCATIONS

ORDERING INFORMATION

AVPL - _____ - _____ - _____

ARM	MOUNTING	FINISH
BXC	1-90..... 	DARK BRONZE
	2-90..... 	BLACK
	2-180..... 	WHITE
	3-90..... 	GREY
	4-90..... 	GREEN
	WALL MOUNT..... 	

CONTACT
FACTORY FOR
DRILLING OPTIONS

ALL RAL COLORS
AVAILABLE