

ATRIA BOLLARD

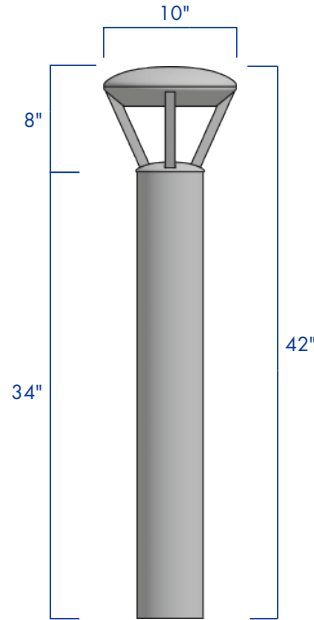

DIMENSIONS



ANCHORAGE

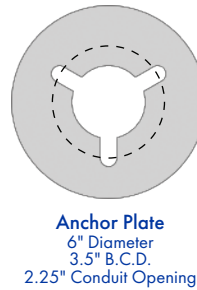
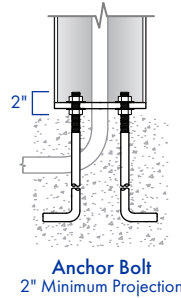

DESCRIPTION

An outstanding traditional design and authentic appearance that is suitable for a variety of lighting applications. The ATR-BOL series by AV Poles and Lighting is ideal for courtyards, pathways, and all low level lighting applications.

FEATURES





- Round extruded, spun, and cast aluminum construction
- Stainless steel hardware
- Acrylic injection molded lenses with smooth clear or opal finish.
- 0-10V dimmable driver
- 10-20KV surge protection
- IP67 rated modules - 5 year warranty
- Up to 180 Lumens Per Watt output
- Low maintenance cost with lifetime >54,000 hrs
- Multiple lighting distribution options with optical lens transmittance up to 98%
- TGIC thermoset polyester powder coat finish is electrostatically applied at a 3.0 mil nominal thickness. A five stage metal pre-treatment process and sealer provide maximum corrosion resistance. The powder top coat is baked in excess of 400 degrees for supreme endurance.



SUITABLE FOR
WET
LOCATIONS



ORDERING INFORMATION

AVPL -	BOLLARD	HEIGHT	WATTAGE	COLOR TEMP	VOLTAGE	OPTICS	FINISH	OPTIONS
ATR-BOL	42"	18W 350mA	3000K WARM WHITE	120-277V VOLTAGE SENSING	TYPE II 	DARK BRONZE	STANCHION MOUNT	
			4000K NEUTRAL WHITE	347-480V VOLTAGE SENSING			BLACK	HOUSE-SIDE SHIELD
			5000K COOL WHITE				WHITE	PHOTOCELL BUTTON
		35W 700mA		TYPE III 	GREY			
				TYPE IV 	GREEN			
55W 1050mA		TYPE V 						

CONTACT FACTORY FOR FULL LUMEN CHART ALL RAL COLORS AVAILABLE

LUMEN OUTPUT CHART

3K	18W 350mA	35W 700mA	55W 1050mA	4K	18W 350mA	35W 700mA	55W 1050mA	5K	18W 350mA	35W 700mA	55W 1050mA
	Type V	2,147	4,177		5,680	Type V	2,279		4,432	6,028	Type V